



LAF 1001 / LAF 1001M



Instruction manual



EU DECLARATION OF CONFORMITY

According to:

The Low Voltage Directive 2014/35/EU; entering into force 20 April 2016
The EMC Directive 2014/30/EU; entering into force 20 April 2016
The RoHS Directive 2011/65/EU; entering into force 2 January 2013

Type of equipment

Arc welding power source

Type designation

LAF 1001, LAF 1001M

from serial number 536 xxx xxx

Brand name or trademark

ESAB

Manufacturer or his authorized representative established within the EEA

ESAB AB
Lindholmsallén 9, Box 8004, SE-402 77 Göteborg, Sweden
Phone: +46 31 50 90 00, www.esab.com

The following EN standards and regulations in force within the EEA has been used in the design:

EN IEC 60974-1:2018/A1:2019	Arc Welding Equipment - Part 1: Welding power sources
EN 60974-10:2014	Arc Welding Equipment - Part 10: Electromagnetic compatibility (EMC) requirements

Additional Information: Restrictive use, Class A equipment, intended for use in location other than residential

By signing this document, the undersigned declares as manufacturer, or the manufacturer's authorised representative established within the EEA, that the equipment in question complies with the safety and environmental requirements stated above.

Date

Signature

Position

Gothenburg
2023-03-23

Peter Kjallstrom

Director Welding Automation

CE 2023

TABLE OF CONTENTS

1	SAFETY	4
1.1	Meaning of symbols	4
1.2	Safety precautions	4
2	INTRODUCTION	7
3	TECHNICAL DATA	8
4	INSTALLATION	9
4.1	Location	9
4.2	Connections	10
5	OPERATION	11
5.1	Controls	11
6	MAINTENANCE	12
6.1	Cleaning	12
6.1.1	Welding power source	12
6.1.2	Contactor	12
7	ORDERING SPARE PARTS	13
	DIAGRAM	14
	CONNECTION INSTRUCTION	16
	ORDERING NUMBERS	18

1 SAFETY

1.1 Meaning of symbols

As used throughout this manual: Means Attention! Be Alert!

**DANGER!**

Means immediate hazards which, if not avoided, will result in immediate, serious personal injury or loss of life.

**WARNING!**

Means potential hazards which could result in personal injury or loss of life.

**CAUTION!**

Means hazards which could result in minor personal injury.

**WARNING!**

Before use, read and understand the instruction manual and follow all labels, employer's safety practices and Safety Data Sheets (SDSs).



1.2 Safety precautions

Users of ESAB equipment have the ultimate responsibility for ensuring that anyone who works on or near the equipment observes all the relevant safety precautions. Safety precautions must meet the requirements that apply to this type of equipment. The following recommendations should be observed in addition to the standard regulations that apply to the workplace.

All work must be carried out by trained personnel well-acquainted with the operation of the equipment. Incorrect operation of the equipment may lead to hazardous situations which can result in injury to the operator and damage to the equipment.

1. Anyone who uses the equipment must be familiar with:
 - its operation
 - location of emergency stops
 - its function
 - relevant safety precautions
 - welding and cutting or other applicable operation of the equipment
2. The operator must ensure that:
 - no unauthorised person is stationed within the working area of the equipment when it is started up
 - no-one is unprotected when the arc is struck or work is started with the equipment
3. The workplace must:
 - be suitable for the purpose
 - be free from drafts

4. Personal safety equipment:
 - Always wear recommended personal safety equipment, such as safety glasses, flame-proof clothing, safety gloves
 - Do not wear loose-fitting items, such as scarves, bracelets, rings, etc., which could become trapped or cause burns
5. General precautions:
 - Make sure the return cable is connected securely
 - Work on high voltage equipment **may only be carried out by a qualified electrician**
 - Appropriate fire extinguishing equipment must be clearly marked and close at hand
 - Lubrication and maintenance must **not** be carried out on the equipment during operation

**WARNING!**

Arc welding and cutting can be injurious to yourself and others. Take precautions when welding and cutting.

**ELECTRIC SHOCK - Can kill**

- Install and ground the unit in accordance with instruction manual.
- Do not touch live electrical parts or electrodes with bare skin, wet gloves or wet clothing.
- Insulate yourself from work and ground.
- Ensure your working position is safe

**ELECTRIC AND MAGNETIC FIELDS - Can be dangerous to health**

- Welders having pacemakers should consult their physician before welding. EMF may interfere with some pacemakers.
- Exposure to EMF may have other health effects which are unknown.
- Welders should use the following procedures to minimize exposure to EMF:
 - Route the electrode and work cables together on the same side of your body. Secure them with tape when possible. Do not place your body between the torch and work cables. Never coil the torch or work cable around your body. Keep welding power source and cables as far away from your body as possible.
 - Connect the work cable to the workpiece as close as possible to the area being welded.

**FUMES AND GASES - Can be dangerous to health**

- Keep your head out of the fumes.
- Use ventilation, extraction at the arc, or both, to take fumes and gases away from your breathing zone and the general area.

**ARC RAYS - Can injure eyes and burn skin**

- Protect your eyes and body. Use the correct welding screen and filter lens and wear protective clothing.
- Protect bystanders with suitable screens or curtains.

**NOISE - Excessive noise can damage hearing**

Protect your ears. Use earmuffs or other hearing protection.

MOVING PARTS - Can cause injuries



- Keep all doors, panels and covers closed and securely in place. Have only qualified people remove covers for maintenance and troubleshooting as necessary. Reinstall panels or covers and close doors when service is finished and before starting engine.



- Stop engine before installing or connecting unit.
- Keep hands, hair, loose clothing and tools away from moving parts.

FIRE HAZARD



- Sparks (spatter) can cause fire. Make sure that there are no inflammable materials nearby.
- Do not use on closed containers.

MALFUNCTION - Call for expert assistance in the event of malfunction.

PROTECT YOURSELF AND OTHERS!



CAUTION!

This product is solely intended for arc welding.



WARNING!

Do not use the power source for thawing frozen pipes.



CAUTION!

Class A equipment is not intended for use in residential locations where the electrical power is provided by the public low-voltage supply system. There may be potential difficulties in ensuring electromagnetic compatibility of class A equipment in those locations, due to conducted as well as radiated disturbances.

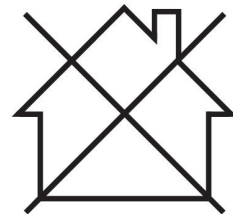

NOTE!

Dispose of electronic equipment at the recycling facility!

In observance of European Directive 2012/19/EC on Waste Electrical and Electronic Equipment and its implementation in accordance with national law, electrical and/or electronic equipment that has reached the end of its life must be disposed of at a recycling facility.

As the person responsible for the equipment, it is your responsibility to obtain information on approved collection stations.

For further information contact the nearest ESAB dealer.



ESAB has an assortment of welding accessories and personal protection equipment for purchase. For ordering information contact your local ESAB dealer or visit us on our website.

2 INTRODUCTION

LAF 1001/ LAF 1001M are remote-controlled 3-phase welding power sources intended for highly productive mechanised gas metal arc welding (MIG/MAG) or submerged arc welding (SAW).

The welding power sources are fan-cooled and are monitored by a thermal cutout against overload. When the thermal cutout is deployed the yellow lamp on the front panel illuminates automatically. The reset is carried out automatically when the temperature has decreased to a permitted level.

3 TECHNICAL DATA

	LAF 1001	LAF 1001M
Mains voltage	380/400/415/500 V, 3~ 50 Hz 440/550 V, 3~ 60 Hz	230/380/400/415/500 V, 3~ 50 Hz 230/440/550 V, 3~ 60 Hz
Z_{max}	0.04 Ohm	0.04 Ohm
Primary current	I _{max} 84 A	I _{max} 138 A
Values of the conventional load:		
100% duty cycle	800 A/44 V	800 A/44 V
60% duty cycle	1000 A/44 V	1000 A/44 V
Setting range SAW	100-1000 A/24-44 V	100-1000 A/24-44 V
S_{sc} min	4.8 MVA	4.8 MVA
No-load voltage	53 V	56 V
No-load power	180 W	178 W
Efficiency at maximum current	90%	86%
Power factor at maximum current	0.95	0.96
Apparent power I₂ at maximum current	51.6 kVA	52.9 kVA
Active power I₂ at maximum current	48.9 kW	51.0 kW
Operating temperature	-10 to +40 °C (+14 to +104 °F)	-10 to +40 °C (+14 to +104 °F)
Weight	330 kg (727.5 lb)	330 kg (727.5 lb)
Dimensions L × W × H	646 × 552 × 1090 mm (25.4 × 21.7 × 42.9 in.)	646 × 552 × 1090 mm (25.4 × 21.7 × 42.9 in.)
Isolation class transformer	H	H
Enclosure class	IP23	IP23
Application class	S	S

Enclosure class

The **IP** code indicates the enclosure class, i.e. the degree of protection against penetration by solid objects or water.

Equipment marked **IP23** is intended for indoor and outdoor use.

Application class

The symbol **S** indicates that the power source is designed for use in areas with increased electrical hazard.

4 INSTALLATION

The installation must be carried out by a professional.



NOTE!

Mains supply requirements

This equipment complies with IEC 61000-3-12 provided that the short-circuit power is greater than or equal to S_{scmin} at the interface point between the user's supply and the public system. It is the responsibility of the installer or user of the equipment to ensure, by consultation with the distribution network operator if necessary, that the equipment is connected only to a supply with a short-circuit power greater than or equal to S_{scmin} . Refer to the technical data in the TECHNICAL DATA chapter.

4.1 Location



WARNING!

Secure the equipment - particularly if the ground is uneven or sloping.

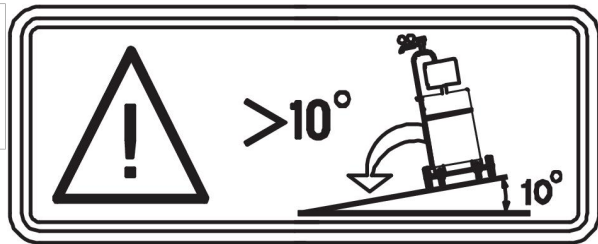

- Place the welding power source on a level foundation.
- Make sure there is nothing to prevent the cooling.

Lifting instructions

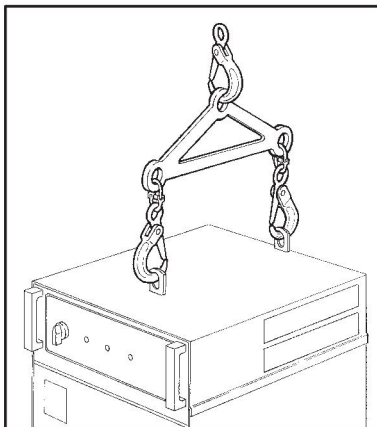

4.2 Connections

- On delivery the welding power source is connected for 400 V.
- For other supply voltage:
Remove the left side plate.
Perform the switchings on the main and control transformer in accordance with the section "Connection instruction".
- Select the mains cable with the correct cable area and fuse the cable with the correct fuse in accordance with local regulations (see the "Main connection" table below).
- Remove the front plates (x 2).

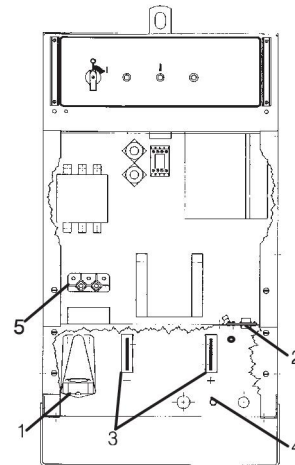

- Connect the ground cable to the screw marked  .
- Tighten the cable clamp (1).
- Connect the mains cables to the main connection terminals L1, L2 and L3 (5).
- Connect the control cable between the welding power source and the control box to the 28-pin connector (2) on the inside of the welding power source.
- Connect the 1-pin measuring cable (4) for measuring the arc voltage to the return cable/welding head.
- Connect a suitable welding and return cable in the connectors (3) marked + and - on the front of the welding power source.
- Fit the side/ front plates.

Mains connection

LAF 1001	50 Hz				60 Hz	
Voltage (V)	380	400	415	500	440	550
Phase current $I_{1\text{eff}}$ (A)	67	64	64	52	64	52
Cable area (mm ²)	4 × 16	4 × 16	4 × 16	4 × 16	4 × 16	4 × 16
Fuse, slow (A)	80	63	63	63	63	63
Miniature circuit breaker (A)	80	80	80	63	80	63

LAF 1001M	50 Hz					60 Hz		
Voltage (V)	230	380	400	415	500	230	440	550
Phase current $I_{1\text{eff}}$ (A)	108	67	64	64	51	108	64	51
Cable area (mm ²)	4 × 50	4 × 16	4 × 16	4 × 16	4 × 16	4 × 50	4 × 16	4 × 16
Fuse, slow (A)	125	80	63	63	63	125	63	63
Miniature circuit breaker (A)	125	80	80	80	63	125	80	63



NOTE!

The mains cable areas and fuse sizes as shown above are in accordance with Swedish regulations. For other regions, supply cables must be suitable for the application and meet local and national regulations.

5 OPERATION

General safety regulations for handling the equipment can be found in the "SAFETY" chapter of this manual. Read it through before you start using the equipment!



WARNING!

Assure that the side panels are closed during operation.



NOTE!

The power source must be set to analogue mode to use the PEI control unit.

5.1 Controls

The front panel contains:

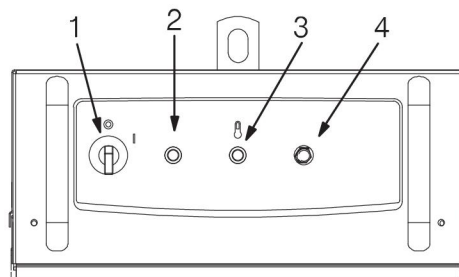

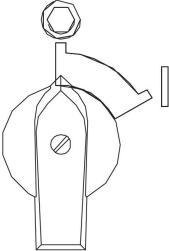
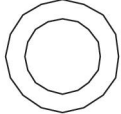
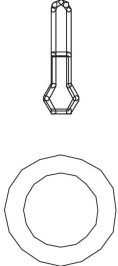
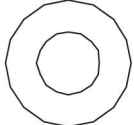
1.		<p>Main circuit-breaker for switching the mains voltage and the fan on and off in the welding power source.</p> <ul style="list-style-type: none"> • Position "1" On • Position "0" Off
2.		<ul style="list-style-type: none"> • The indicator lamp (white) illuminates when the main switch is switched on.
3.		<p>Indicator lamp for overheating (yellow)</p> <ul style="list-style-type: none"> • The indicator lamp illuminates when the thermal cutout is deployed due to excess temperature in the welding power source. • The indicator lamp goes out when the temperature in the welding power source has decreased to a permitted level.
4.		<p>Pushbutton resetting the automatic fuse FU2 for 42 V supply voltage.</p>

6 MAINTENANCE



CAUTION!

All warranty undertakings from the supplier cease to apply if the customer attempts any work to rectify any faults in the product during the warranty period.

6.1 Cleaning

6.1.1 Welding power source



WARNING!

Blocked air inlets or outlets will lead to overheating.

- Clean the welding power source as necessary.
Dry compressed air is recommended for the purpose.

6.1.2 Contactor



WARNING!

Never use compressed air to clean the contactor without first taking it apart completely.



NOTE!

To ensure the reliable operation of the contactor, the magnetic parts must be kept clean.

If the contactor has to be cleaned it must be taken apart, and all the pieces be cleaned.

Alternatively, the contactor can be replaced.

7 ORDERING SPARE PARTS



CAUTION!

Repair and electrical work should be performed by an authorised ESAB service technician. Use only ESAB original spare and wear parts.

LAF 1001 / LAF 1001M is designed and tested in accordance with the international and European standards 60974-1 and 60974-10. It is the obligation of the service unit which has carried out the service or repair work to make sure that the product still conforms to the said standard.

Spare parts and wear parts can be ordered through your nearest ESAB dealer, see [esab.com](https://www.esab.com). When ordering, please state product type, serial number, designation and spare part number in accordance with the spare parts list. This facilitates dispatch and ensures correct delivery.

DIAGRAM

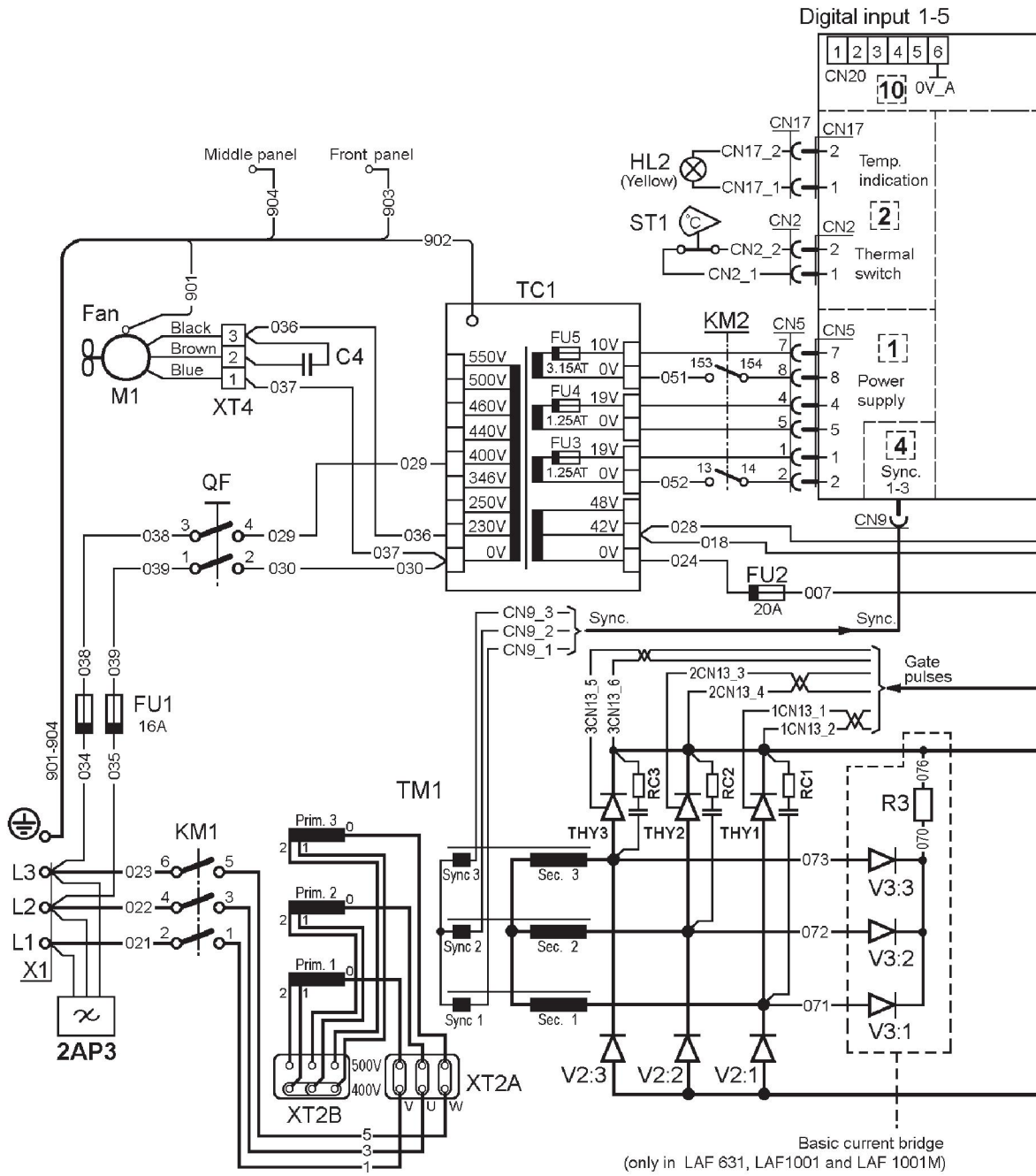

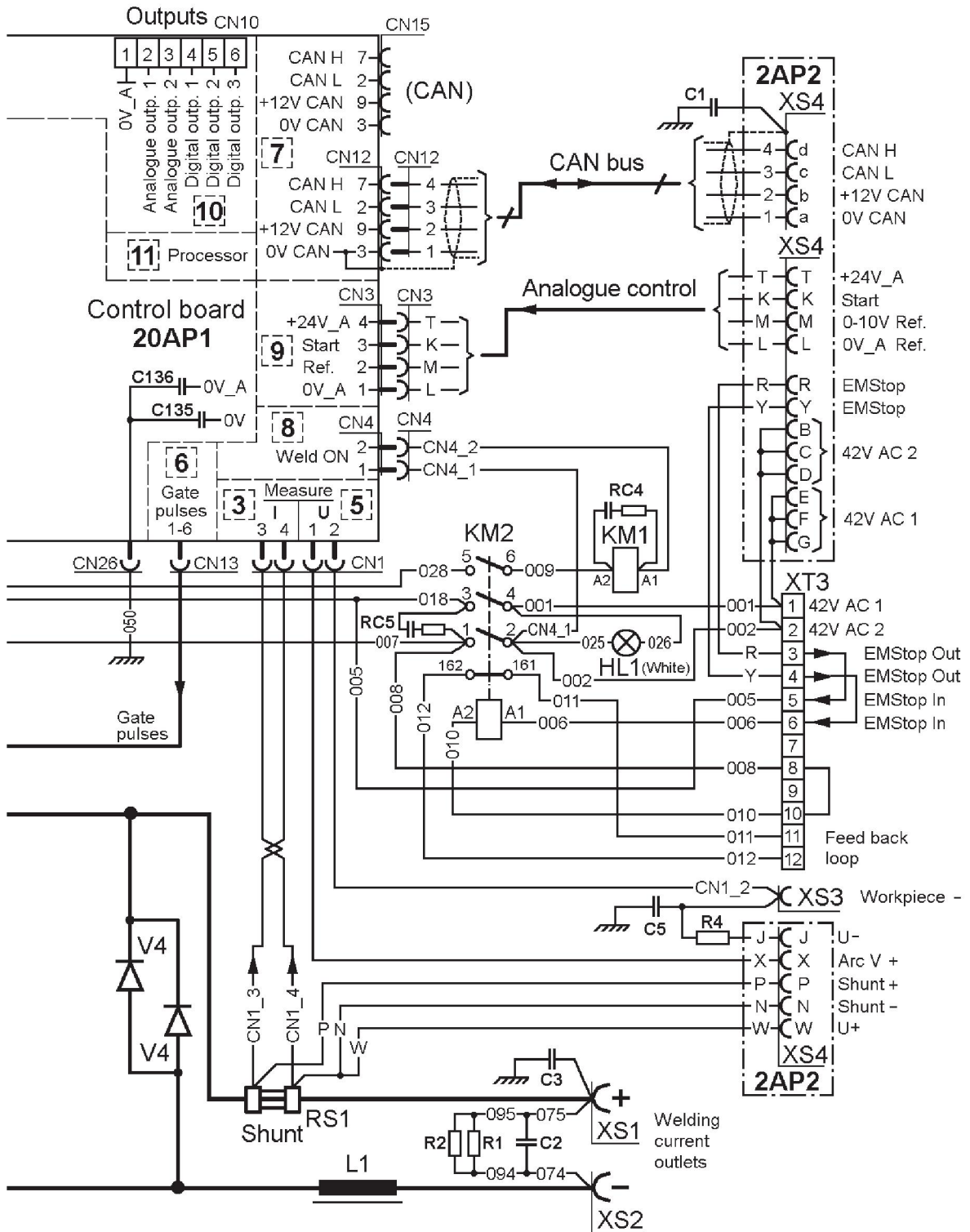

CONNECTION INSTRUCTION

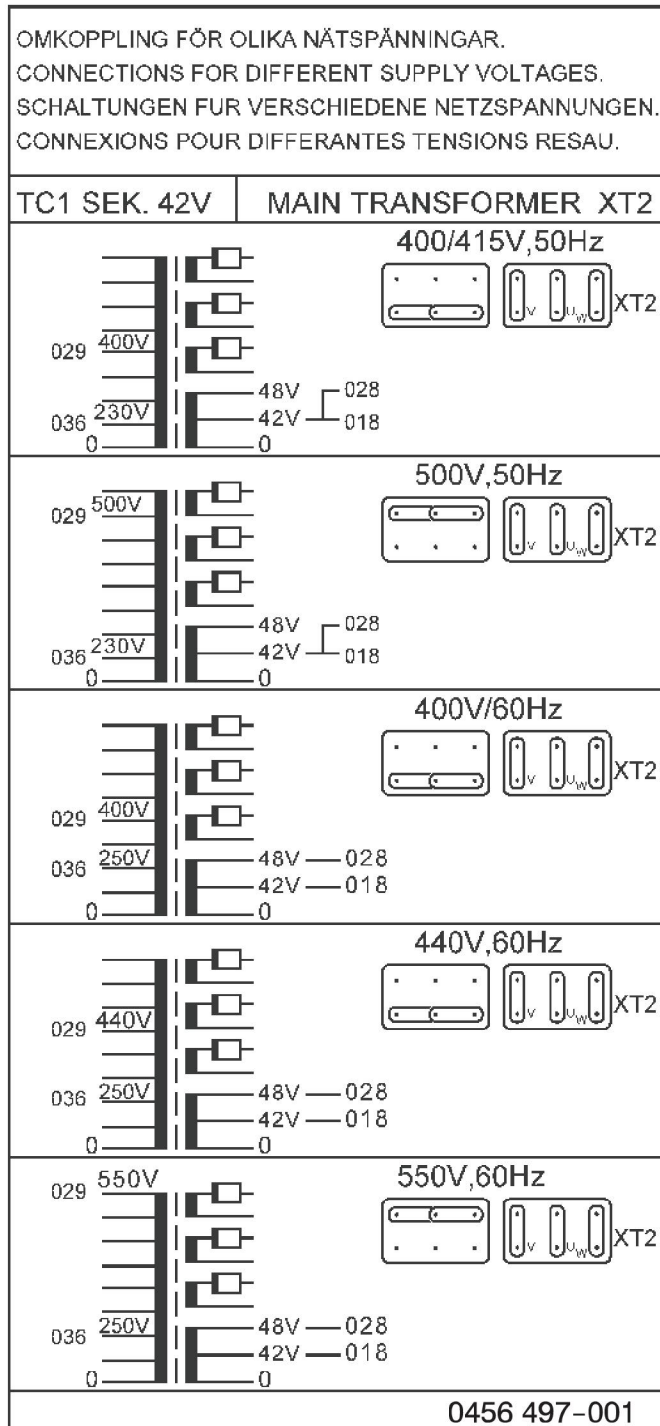

OMKOPPLING FÖR OLIKA NÄTSPÄNNINGAR.
 CONNECTIONS FOR DIFFERENT SUPPLY VOLTAGES.
 SCHALTUNGEN FÜR VERSCHIEDENE NETZSPANNUNGEN.
 CONNEXIONS POUR DIFFERANTES TENSIONS RESAU.

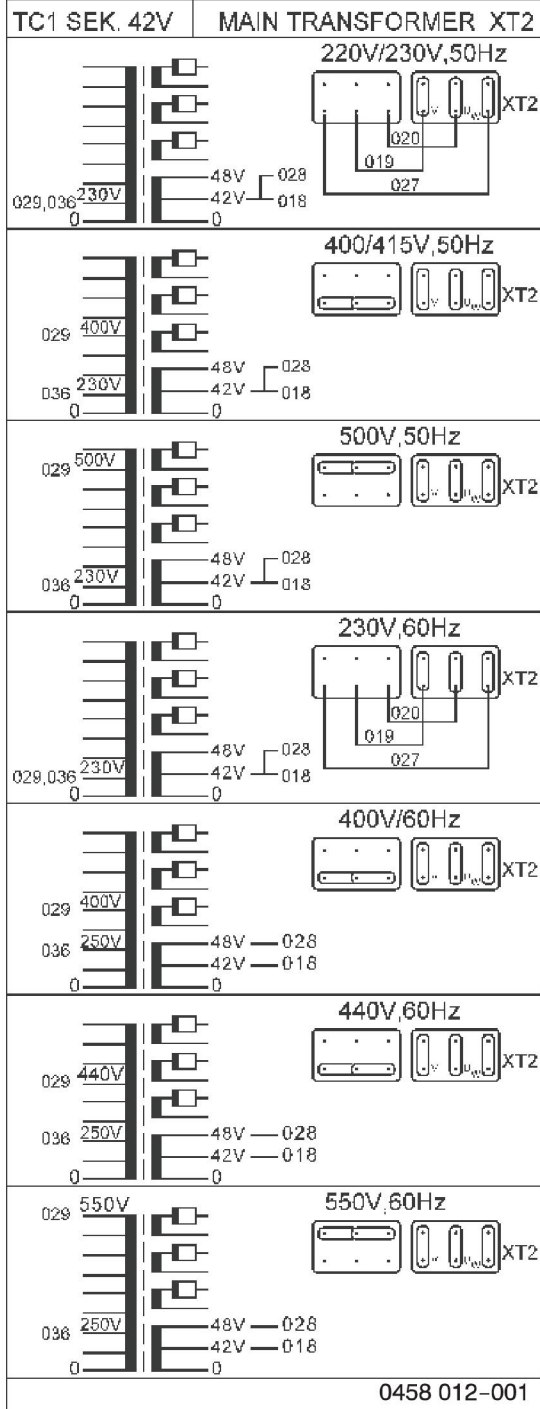

ORDERING NUMBERS



Ordering no.	Denomination	Type
0460 513 880	Welding power source	LAF 1001
0460 513 881	Welding power source	LAF 1001M
0459 839 057	Spare parts list	LAF 1001 / LAF 1001M

Technical documentation is available on the Internet at: www.esab.com



A WORLD OF PRODUCTS AND SOLUTIONS.



For contact information visit esab.com

ESAB AB, Lindholmsallén 9, Box 8004, 402 77 Gothenburg, Sweden, Phone +46 (0) 31 50 90 00

manuals.esab.com

