

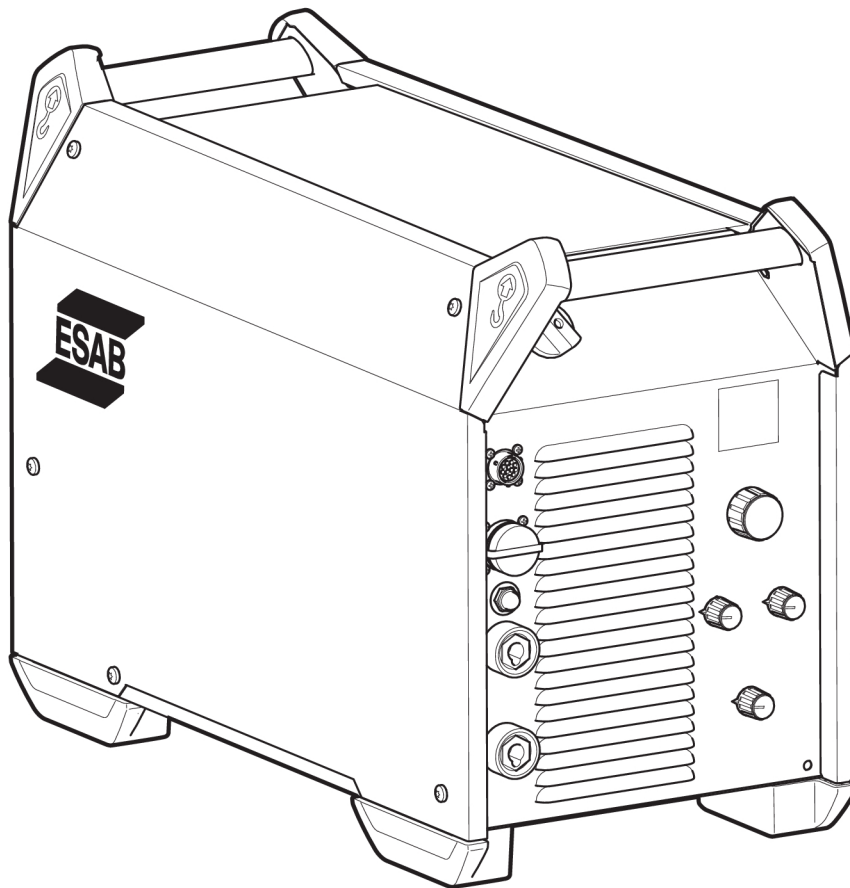

# **Warrior™ 500i ECHO CC/CV**



## **Instruction manual**



## EU DECLARATION OF CONFORMITY

**According to:**

The Low Voltage Directive 2014/35/EU;  
The RoHS Directive 2011/65/EU;

The EMC Directive 2014/30/EU;  
The Ecodesign Directive 2009/125/EC

**Type of equipment**

Arc welding power source

**Type designation**

Warrior 500i ECHO CC/CV

With serial number OP441 YY XX XXXX

**Brand name or trademark**

ESAB

**Manufacturer or his authorised representative established within the EEA**

ESAB AB

Lindholmsallén 9, Box 8004, SE-402 77 Göteborg, Sweden

Phone: +46 31 50 90 00, [www.esab.com](http://www.esab.com)

**The following EN standards and regulations in force within the EEA has been used in the design:**

EN IEC 60974-1:2018/A1:2019	Arc Welding Equipment - Part 1: Welding power sources
EU reg. no. 2019/1784	Ecodesign requirements for welding equipment pursuant to Directive 2009/125/EC
EN 60974-10:2020	Arc Welding Equipment - Part 10: Electromagnetic compatibility (EMC) requirements

**Additional Information:**

Restrictive use, Class A equipment, intended for use in locations other than residential.

**By signing this document, the undersigned declares as manufacturer, or the manufacturer's authorised representative established within the EEA, that the equipment in question complies with the safety and environmental requirements stated above.**

**Place/Date**

Gothenburg  
2024-10-01

**Signature**

Peter Burchfield  
General Manager, Equipment Solutions





## EU DECLARATION OF CONFORMITY

**According to:**

The Low Voltage Directive 2014/35/EU;      The EMC Directive 2014/30/EU;  
The RoHS Directive 2011/65/EU;              The Ecodesign Directive 2009/125/EC

**Type of equipment**

Arc welding power source

**Type designation**

Warrior 500i ECHO CC/CV                      With serial number      OP451 YY XX XXXX

**Brand name or trademark**

ESAB

**Manufacturer or his authorised representative established within the EEA**

ESAB AB  
Lindholmsallén 9, Box 8004, SE-402 77 Göteborg, Sweden  
Phone: +46 31 50 90 00, [www.esab.com](http://www.esab.com)

**The following EN standards and regulations in force within the EEA has been used in the design:**

EN IEC 60974-1:2018/A1:2019	Arc Welding Equipment - Part 1: Welding power sources
EU reg. no. 2019/1784	Ecodesign requirements for welding equipment pursuant to Directive 2009/125/EC
IEC EN 60974-10:2020	Arc Welding Equipment - Part 10: Electromagnetic compatibility (EMC) requirements

**Additional Information:**

Restrictive use, Class A equipment, intended for use in locations other than residential.

**By signing this document, the undersigned declares as manufacturer, or the manufacturer's authorised representative established within the EEA, that the equipment in question complies with the safety and environmental requirements stated above.**

**Place/Date**

Gothenburg  
2025-01-27

**Signature**

Peter Burchfield  
General Manager, Equipment Solutions





## UK DECLARATION OF CONFORMITY

According to:

- Electric Equipment (Safety) Regulations 2016;
- Electromagnetic Compatibility Regulations 2016;
- The Restriction of the Use of Certain Hazardous Substances in Electrical and Electronic Equipment Regulations 2012 (as amended)
- The Ecodesign for Energy-Related Products and Energy Information Regulations 2021

Type of equipment

Arc welding power source

Type designation

Warrior 500i ECHO CC/CV

with serial number from OP451 YY XX XXXX

X and Y represents digits, 0 to 9 in the serial number, where YY indicates year of production.

Brand name or trademark

ESAB

Manufacturer or his authorised representative established within United Kingdom

ESAB Group (UK) Ltd,

322 High Holborn, London, WC1V 7PB, United Kingdom

[www.esab.co.uk](http://www.esab.co.uk)

The following British Standards and Instruments in force within the United Kingdom has been used in the design:

- EN IEC 60974-1:2018/A1:2019	Arc welding equipment - Part 1: Welding power sources
- IEC EN 60974-10:2020	Arc welding equipment - Part 10: Electromagnetic compatibility (EMC)
- UK S.I. 2021/745	Requirements for welding equipment pursuant to the Ecodesign for Energy-Related Products and Energy Information Regulations 2021

Additional Information:

Restrictive use, Class A equipment, intended for use in locations other than residential.

By signing this document, the undersigned declares as manufacturer, or the manufacturer's authorised representative established within the UK, that the equipment in question complies with the safety and environmental requirements stated above.

Signatures

David Todd

Commercial Director,

ESAB Group UK & Ireland

London, 2025-01-28

<b>1</b>	<b>SAFETY</b> .....	<b>6</b>
1.1	Meaning of symbols .....	6
1.2	Safety precautions .....	6
<b>2</b>	<b>INTRODUCTION</b> .....	<b>9</b>
2.1	Overview .....	9
2.2	Equipment .....	9
<b>3</b>	<b>TECHNICAL DATA</b> .....	<b>10</b>
<b>4</b>	<b>INSTALLATION</b> .....	<b>12</b>
4.1	General .....	12
4.2	Lifting instructions .....	12
4.3	Location .....	13
4.4	Mains supply .....	13
<b>5</b>	<b>OPERATION</b> .....	<b>16</b>
5.1	Connections and control devices .....	16
5.2	Connection of welding and return cables .....	16
5.3	Turning the mains power on/off .....	17
5.4	Fan control .....	17
5.5	Symbols and functions .....	18
<b>6</b>	<b>MAINTENANCE</b> .....	<b>21</b>
6.1	Routine maintenance .....	21
6.2	Cleaning instructions .....	21
6.2.1	Cleaning procedure .....	22
<b>7</b>	<b>TROUBLESHOOTING</b> .....	<b>23</b>
<b>8</b>	<b>ORDERING SPARE PARTS</b> .....	<b>24</b>
	<b>DIAGRAM</b> .....	<b>25</b>
	<b>ORDERING NUMBERS</b> .....	<b>26</b>
	<b>ACCESSORIES</b> .....	<b>27</b>

# 1 SAFETY

## 1.1 Meaning of symbols

As used throughout this manual: Means Attention! Be Alert!



### DANGER!

Means immediate hazards which, if not avoided, will result in immediate, serious personal injury or loss of life.



### WARNING!

Means potential hazards which could result in personal injury or loss of life.



### CAUTION!

Means hazards which could result in minor personal injury.



### WARNING!

Before use, read and understand the instruction manual and follow all labels, employer's safety practices and Safety Data Sheets (SDSs).



## 1.2 Safety precautions

Users of ESAB equipment have the ultimate responsibility for ensuring that anyone who works on or near the equipment observes all the relevant safety precautions. Safety precautions must meet the requirements that apply to this type of equipment. The following recommendations should be observed in addition to the standard regulations that apply to the workplace.

All work must be carried out by trained personnel well-acquainted with the operation of the equipment. Incorrect operation of the equipment may lead to hazardous situations which can result in injury to the operator and damage to the equipment.

1. Anyone who uses the equipment must be familiar with:
  - its operation
  - location of emergency stops
  - its function
  - relevant safety precautions
  - welding and cutting or other applicable operation of the equipment
2. The operator must ensure that:
  - no unauthorised person is stationed within the working area of the equipment when it is started up
  - no-one is unprotected when the arc is struck or work is started with the equipment
3. The workplace must:
  - be suitable for the purpose
  - be free from drafts

4. Personal safety equipment:
  - Always wear recommended personal safety equipment, such as safety glasses, flame-proof clothing, safety gloves
  - Do not wear loose-fitting items, such as scarves, bracelets, rings, etc., which could become trapped or cause burns
5. General precautions:
  - Make sure the return cable is connected securely
  - Work on high voltage equipment **may only be carried out by a qualified electrician**
  - Appropriate fire extinguishing equipment must be clearly marked and close at hand
  - Lubrication and maintenance must **not** be carried out on the equipment during operation

**WARNING!**

Arc welding and cutting can be injurious to yourself and others. Take precautions when welding and cutting.

**ELECTRIC SHOCK - Can kill**

- Install and ground the unit in accordance with instruction manual.
- Do not touch live electrical parts or electrodes with bare skin, wet gloves or wet clothing.
- Insulate yourself from work and ground.
- Ensure your working position is safe

**ELECTRIC AND MAGNETIC FIELDS - Can be dangerous to health**

- Welders having pacemakers should consult their physician before welding. EMF may interfere with some pacemakers.
- Exposure to EMF may have other health effects which are unknown.
- Welders should use the following procedures to minimize exposure to EMF:
  - Route the electrode and work cables together on the same side of your body. Secure them with tape when possible. Do not place your body between the torch and work cables. Never coil the torch or work cable around your body. Keep welding power source and cables as far away from your body as possible.
  - Connect the work cable to the workpiece as close as possible to the area being welded.

**FUMES AND GASES - Can be dangerous to health**

- Keep your head out of the fumes.
- Use ventilation, extraction at the arc, or both, to take fumes and gases away from your breathing zone and the general area.

**ARC RAYS - Can injure eyes and burn skin**

- Protect your eyes and body. Use the correct welding screen and filter lens and wear protective clothing.
- Protect bystanders with suitable screens or curtains.

**NOISE - Excessive noise can damage hearing**

Protect your ears. Use earmuffs or other hearing protection.



**MOVING PARTS - Can cause injuries**

- Keep all doors, panels, guards, and covers closed and securely in place.
- Have only qualified people remove covers for maintenance and troubleshooting as necessary.
- Keep hands, hair, loose clothing and tools away from moving parts.
- Reinstall panels or covers and close doors when service is finished and before starting the unit.



**FIRE HAZARD**

- Sparks (spatter) can cause fire. Make sure that there are no inflammable materials nearby.
- Do not use on closed containers.



**CAUTION!**

This product is solely intended for arc welding.



**CAUTION!**

Class A equipment is not intended for use in residential locations where the electrical power is provided by the public low-voltage supply system. There may be potential difficulties in ensuring electromagnetic compatibility of class A equipment in those locations, due to conducted as well as radiated disturbances.

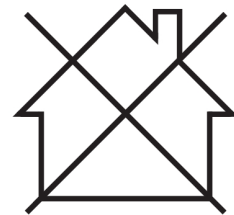

**NOTE!**

**Dispose of electronic equipment at the recycling facility!**

In observance of European Directive 2012/19/EC on Waste Electrical and Electronic Equipment and its implementation in accordance with national law, electrical and/or electronic equipment that has reached the end of its life must be disposed of at a recycling facility.

As the person responsible for the equipment, it is your responsibility to obtain information on approved collection stations.

For further information contact the nearest ESAB dealer.

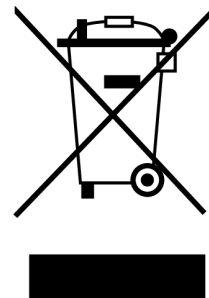

**ESAB has an assortment of welding accessories and personal protection equipment for purchase. For ordering information contact your local ESAB dealer or visit us on our website.**

## 2 INTRODUCTION

---

### 2.1 Overview

The **Warrior™ 500i ECHO CC/CV** is a welding power source intended for MIG/MAG welding, as well as for welding with powder filled cored wire (FCAW-S), for TIG welding, for welding with coated electrodes (MMA) and for arc air gouging.

Warrior™ 500i ECHO CC/CV has built-in communication through the welding cables with RobustFeed AVS ECHO.

The power sources are intended for use with the following wire feed units:

- RobustFeed PRO
- RobustFeed AVS
- RobustFeed AVS ECHO
- Warrior™ Feed 304
- Warrior™ Feed 304w

**ESAB accessories for the product can be found in the "ACCESSORIES" chapter of this manual.**

### 2.2 Equipment

The power source is supplied with:

- 5 m (16 ft) return cable with earth clamp
- 5 m (16 ft) mains cable
- Instruction manual
- Quick start guide
- Safety instruction

### 3 TECHNICAL DATA

<b>Warrior™ 500i ECHO CC/CV</b>	
<b>Mains voltage</b>	380-415 V ±10%, 3~ 50/60 Hz
<b>Mains supply <math>S_{scmin}</math></b>	7.2 MVA
<b>Mains supply <math>Z_{max}</math></b>	0.022 Ω
<b>Primary current <math>I_{max}</math></b>	
MIG/MAG	37 A
TIG	30 A
MMA	38 A
<b>Idle power</b>	21.3 W
<b>Setting range</b>	
MIG/MAG	16 A/15 V - 500 A/39 V
TIG	5 A/10 V - 500 A/30 V
MMA	16 A/20 V - 500 A/40 V
<b>Permissible load at MIG/MAG</b>	
60 % duty cycle	500 A/39 V
100% duty cycle	400 A/34 V
<b>Permissible load at TIG</b>	
60 % duty cycle	500 A/30 V
100% duty cycle	400 A/26 V
<b>Permissible load at MMA</b>	
60 % duty cycle	500 A/40 V
100% duty cycle	400 A/36 V
<b>Power factor</b> at maximum current	0.91
<b>Efficiency</b> at maximum current	90 %
<b>Electrode types</b>	Basic Rutile Cellulosic
<b>Open-circuit voltage</b>	
VRD deactivated	56 V DC peak
VRD activated	28 V DC peak
<b>Apparent power</b> at maximum current	24.6 kVA
<b>Active power</b> at maximum current	22.5 kW
<b>Operating temperature</b>	-10 to +40°C
<b>Transportation temperature</b>	-20 to +55°C
<b>Constant sound pressure when idling</b>	<70 db (A)
<b>Dimensions l × w × h</b>	712 × 325 × 470 mm
<b>Weight</b>	58.5 kg
<b>Insulation class</b>	H

<b>Warrior™ 500i ECHO CC/CV</b>	
<b>Enclosure class</b>	IP 23
<b>Application class</b>	S

**Mains supply,  $S_{sc\ min}$** 

Minimum short circuit power on the network in accordance with IEC 61000-3-12.

**Mains supply,  $Z_{max}$** 

Maximum permissible line impedance of the network in accordance with IEC 61000-3-11.

**Duty cycle**

The duty cycle refers to the time as a percentage of a ten-minute period that you can weld or cut at a certain load without overloading. The duty cycle is valid for 40 °C / 104 °F, or below.

**Enclosure class**

The **IP** code indicates the enclosure class, i.e. the degree of protection against penetration by solid objects or water.

Equipment marked **IP23** is intended for indoor and outdoor use.

**Application class**

The symbol S indicates that the power source is designed for use in areas with increased electrical hazard.

## 4 INSTALLATION

### 4.1 General

The installation must be carried out by a professional.

### 4.2 Lifting instructions

Max 80.3 kg/177 lbs

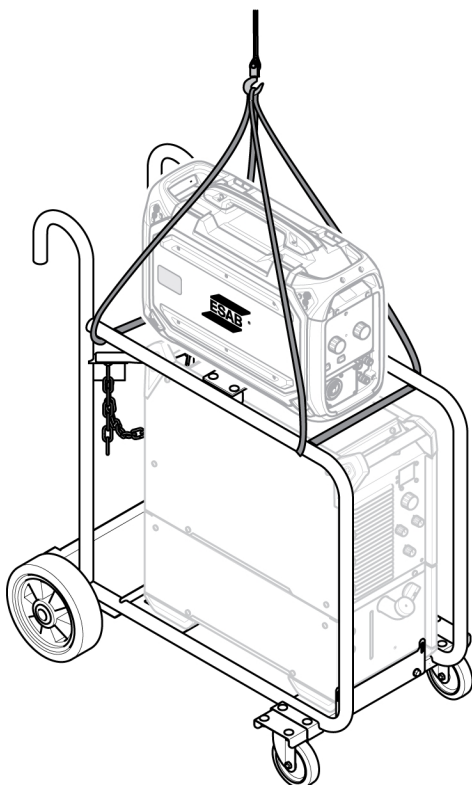
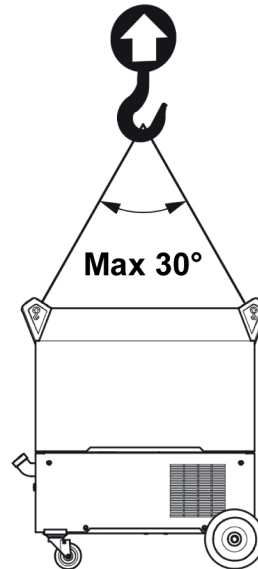
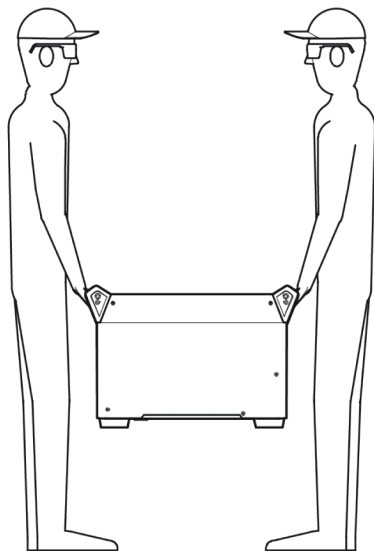



**WARNING!**

Secure the equipment - particularly if the ground is uneven or sloping.

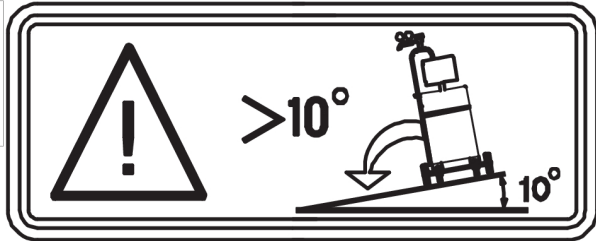

### 4.3 Location

Position the welding power source such that its cooling air inlets and outlets are not obstructed.

### 4.4 Mains supply



**NOTE!**

**Mains supply requirements**

This equipment complies with IEC 61000-3-12 provided that the short-circuit power is greater than or equal to  $S_{scmin}$  at the interface point between the user's supply and the public system. It is the responsibility of the installer or user of the equipment to ensure, by consultation with the distribution network operator if necessary, that the equipment is connected only to a supply with a short-circuit power greater than or equal to  $S_{scmin}$ . Refer to the technical data in the TECHNICAL DATA chapter.

Make sure that the welding power source is connected to the correct supply voltage and that it is protected by the correct fuse rating. A protective earth connection must be made in accordance with regulations.

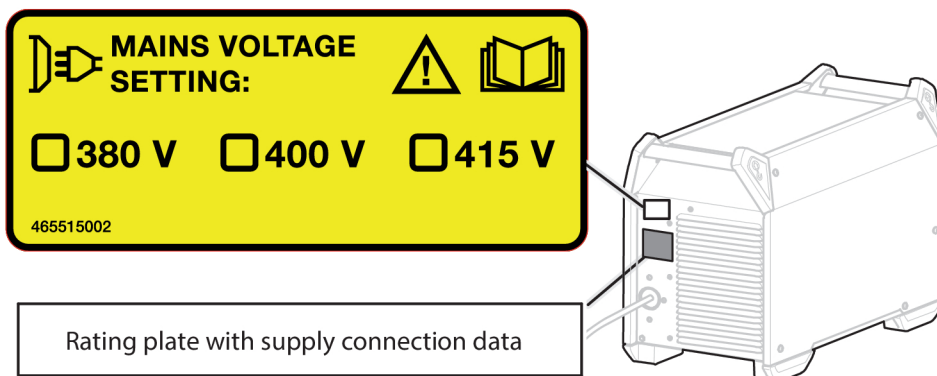

*Recommended fuse sizes and minimum cable area Warrior™ 500i ECHO CC/CV*

<b>Warrior™ 500i ECHO CC/CV</b>			
<b>Mains voltage</b>	380 V 3~ 50/60 Hz	400 V 3~ 50/60 Hz	415 V 3~ 50/60 Hz
<b>Mains cable area</b>	4 × 6 mm <sup>2</sup>	4 × 6 mm <sup>2</sup>	4 × 6 mm <sup>2</sup>
<b>Maximal current rating <math>I_{max}</math></b>	38 A	36 A	35 A

$I_{1\text{eff}}$ MIG/MAG	28 A	27 A	26 A
TIG	23 A	22 A	26 A
MMA	29 A	28 A	26 A
<b>Fuse</b>			
anti-surge	35 A	35 A	35 A
type C MCB	32 A	32 A	32 A

**NOTE!**

The mains cable areas and fuse sizes as shown above are in accordance with Swedish regulations. Use the power source in accordance with the relevant national regulations.

**Supply from power generators**

The power source can be supplied from different types of generators. However, some generators may not provide sufficient power for the welding power source to operate correctly. Generators with Automatic Voltage Regulation (AVR) or with equivalent or better type of regulation, with rated power  $\geq 40$  kW, are recommended.

**Connection instruction**

The power source is factory set to 400 V AC. If another mains voltage setting is required, the cable on the printed circuit board has to be moved and put in the correct position. Also the label, at the rear of the power source, marked with the mains voltage setting must be updated. This operation must be done by a person who has the appropriate electrical knowledge.

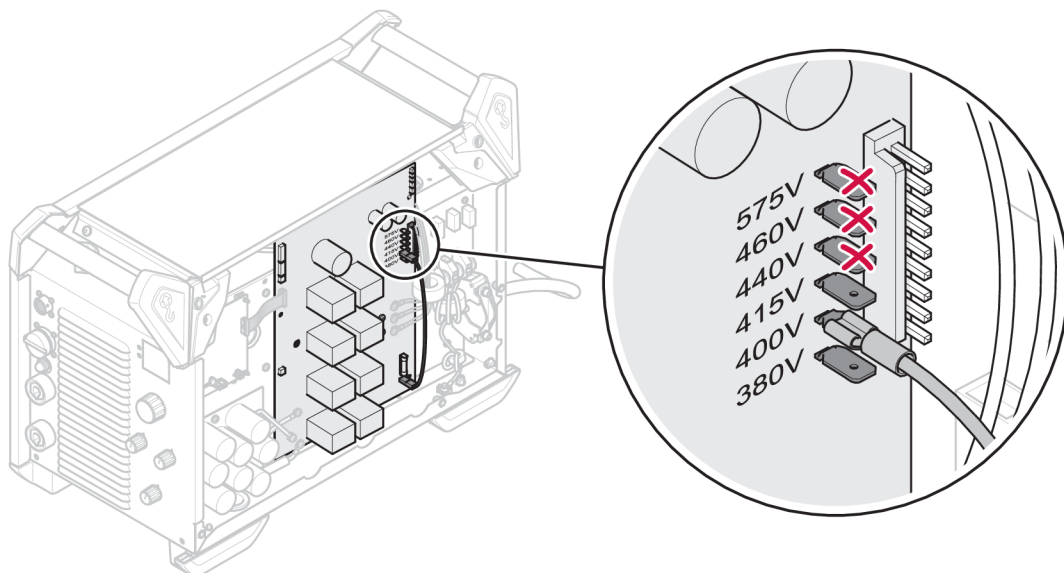
**NOTE!**

This power source version is designed for a nominal input voltage from 380 to 415 V AC. ESAB does not recommend a connection of the cable on the circuit board in the position of 440 , 460 or 575 V AC.



## 5 OPERATION

General safety regulations for handling the equipment can be found in the "SAFETY" chapter of this manual. Read it through before you start using the equipment!



### NOTE!

When moving the equipment use intended handle. Never pull the cables.



### WARNING!

Electric shock! Do not touch the workpiece or the welding head during operation!

### 5.1 Connections and control devices

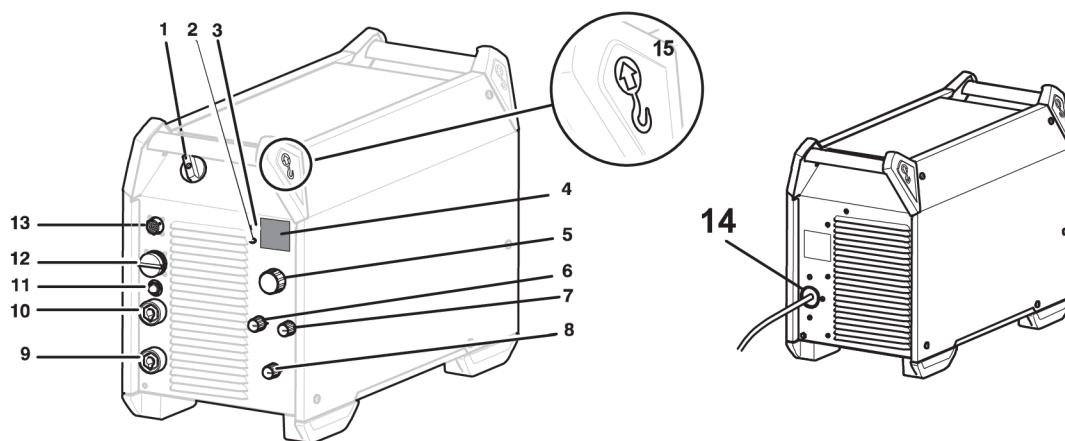

- |   |   |
|---|---|
| 1. Mains power supply switch, O/I   | 9. Connection (-): MIG/MAG: Return cable<br>TiG: Welding torch MMA: Return cable<br>or welding cable, OKC 50 (FEMALE)     |
| 2. Indicator lamp, yellow, overheating  | 10. Connection (+): MIG/MAG: Welding<br>cable TiG: Return cable MMA: Welding<br>cable or return cable, OKC 50<br>(FEMALE) |
| 3. Indicator lamp, green, VRD function<br>(reduced open-circuit voltage)                      | 11. Circuit breaker, 10 A, 42 V   |
| 4. Display, current (A) and voltage (V)   | 12. Connection of wire feed unit, 19 pole<br>Amphenol connector   |
| 5. Knob for setting: MMA/TIG Arc air<br>gouging: Current (A) Mobile Feed<br>mode: Voltage (V) | 13. Connection of remote control unit<br>(option)   |
| 6. Knob for selecting electrode type  | 14. Connection of mains power supply  |
| 7. Knob for inductance (MIG/MAG) and<br>arc force (MMA):                                      | 15. Lifting eye bolt  |
| 8. Knob for welding method  |   |

### 5.2 Connection of welding and return cables

The power source has two outputs, a positive terminal (+) and a negative terminal (-), for connecting welding and return cables. The output to which the welding cable is connected depends on the welding method or type of electrode used.

Connect the return cable to the other output on the power source. Secure the return cable's contact clamp to the work piece and ensure that there is good contact between the work piece and the output for the return cable on the power source.

For MMA welding, the welding cable can be connected to the positive terminal (+) or negative terminal (-) depending on the type of electrode used. The connecting polarity is stated on the electrode packaging.

### Recommended maximum current values for connection set cables

At an ambient temperature of +25 °C and normal 10 minutes cycle:

Cable area	Duty cycle		Voltage loss/10 m
	100%	60%	
70 mm <sup>2</sup>	360	400	0.25 V/100 A
95 mm <sup>2</sup>	430	500	0.19 V/100 A

At an ambient temperature of +40 °C and normal 10 minutes cycle:

Cable area	Duty cycle		Voltage loss/10 m
	100%	60%	
70 mm <sup>2</sup>	310	350	0.27 V/100 A
95 mm <sup>2</sup>	370	430	0.20 V/100 A

### Duty cycle

The duty cycle refers to the time as a percentage of a ten-minute period that you can weld or cut at a certain load without overloading. The duty cycle is valid for 40 °C / 104 °F, or below.

## 5.3 Turning the mains power on/off

Turn on the mains power by turning switch to the "I" position, see 1 on the picture above.

Turn the unit off by turning the switch to the "O" position.

Whether the mains power supply is interrupted or the power source is switched off in the normal manner, welding data will be stored so that it is available next time the unit is started.













### CAUTION!

Do not turn off the power source during welding (with load).

## 5.4 Fan control

The power source has a time control that means that the fans continue to run for 6.5 minutes after welding has stopped, and the power source switches to energy-saving mode. The fans start again when welding restarts.

## 5.5 Symbols and functions

	Placement of lifting eye	VRD	Voltage Reducing Device
	Overheating protection	Basic	Basic electrode
Rutile	Rutile electrode	Cel	Cellulosic electrode
	Arc force		Inductance
	TIG welding (Live TIG)		Arc air gouging
	MMA welding		MIG/MAG welding
	Wire feed unit Mobile feed CV (Constant voltage)		Protective earth

### Voltage reducing device (VRD)

The VRD function ensures that the open-circuit voltage does not exceed 35 V when welding is not being carried out. This is indicated by a lit VRD led.

The VRD function is blocked when the system senses that welding has started.

Contact an authorised ESAB service technician to activate the function.

### Overheating protection

The welding power source has overheating protection that operates if the temperature becomes too high. When this occurs the welding current is interrupted and an overheating indication lamp is lit.

The overheating protection resets automatically when the temperature has fallen, within normal working temperature.

### Arc force

The arc force is important in determining how the current changes in response to a change in the arc length. A lower value gives a calmer arc with less spatter.

It only applies to MMA welding.

### Inductance

Higher inductance results in a wider weld pool and less spatter. Lower inductance produces a harsher sound but a stable, concentrated arc.

It only applies to MIG/MAG welding.

### TIG welding

TIG welding melts the metal of the workpiece, using an arc struck from a tungsten electrode, which does not itself melt. The weld pool and the electrode are protected by shielding gas.

"Live TIG-start"

At a "Live TIG-start" the tungsten electrode is placed against the workpiece. When the electrode is lifted away from workpiece, the arc is struck at a limited current level.



For TIG welding, the welding power source shall be supplemented with:

- a TIG torch with gas valve
- an argon gas cylinder
- an argon gas regulator
- tungsten electrode

### Arc air gouging

With arc air gouging, a special electrode comprising a carbon rod with a copper casing is used.

An arc is formed between the carbon rod and the workpiece, which melts the material. Compressed air is supplied so that the melted material is blown away.

For arc air gouging the power source shall be supplemented with:

- arc air torches
- return cable with clamp
- air pressure

*Recommended for gouging*

Electrode	Voltage min.	Voltage max.	Electrode Extension
6 mm (1/4")	36 V	49 V	50 - 76 mm (2 - 3")
8 mm (5/16")	39 V	52 V	
10 mm (3/8")	43 V	52 V	

### MMA welding

MMA welding may also be referred to as welding with coated electrodes. Striking the arc melts the electrode, and its coating forms protective slag.

For MMA welding the power source shall be supplemented with:

- welding cable with electrode holder
- return cable with clamp

### **MIG/MAG and self shielded cored wire welding**

An arc melts a continuously supplied wire. The weld pool is protected by shielding gas.

For MIG/MAG and self shielded core wire welding, the power source shall be supplemented with:

- wire feed unit
- welding torch
- connection cable between power source and wire feed unit
- gas cylinder
- return cable with clamp

## 6 MAINTENANCE



### WARNING!

The mains supply must be disconnected during cleaning and maintenance.



### CAUTION!

Only persons with the appropriate electrical knowledge (authorised personnel) may remove the safety plates.



### CAUTION!

The product is covered by manufacturer's warranty. Any attempt to carry out repair work by non-authorised service centers or personnel will invalidate the warranty.



### NOTE!

Regular maintenance is important for safe and reliable operation.



### NOTE!





Perform maintenance more often during severe dusty conditions.

Before each use - make sure that:

- Product and cables are not damaged
- The torch is clean and not damaged

### 6.1 Routine maintenance

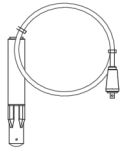
Maintenance schedule during normal conditions. Check equipment prior to every use.

Interval	Area to maintain		
Every 3 months	 Clean or replace unreadable labels.	 Clean weld terminals.	 Check or replace weld cables.
Every 12 months or depending on environmental conditions (by authorised service technician)	 Clean inside equipment. Use dry compressed air with 4 bar pressure.		

### 6.2 Cleaning instructions

To maintain the performance and increase the lifetime of the power source it is mandatory to clean the product regularly. How often depends on:

- the welding process
- the arc time

- the working environment
- the surrounding environment, that is grinding etc.

Tools needed for the cleaning procedure:

- torx screwdriver, T25 and T30
- dry compressed air at a pressure of 4 bar
- protective equipment like ear plugs, safety glasses, masks, gloves and safety shoes



**CAUTION!**

Make sure that the cleaning procedure is done in a suitable prepared workspace.

**6.2.1 Cleaning procedure**

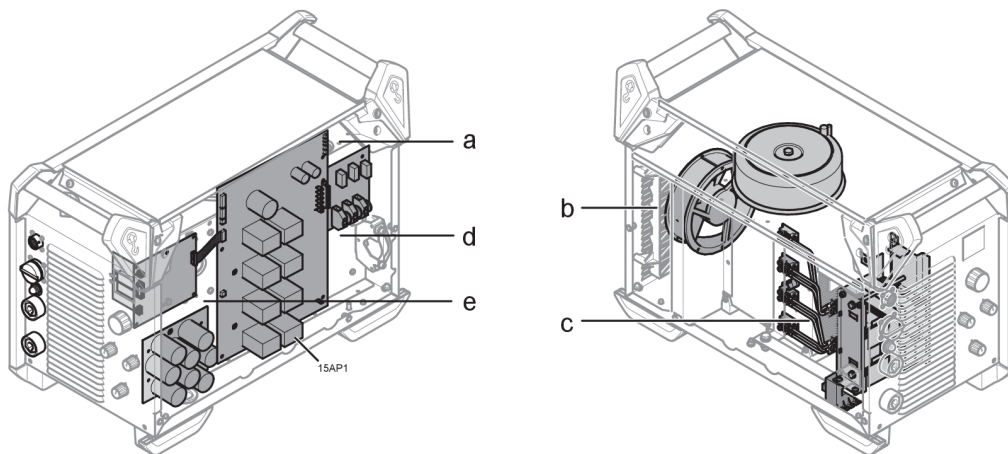

**CAUTION!**

The cleaning procedure should be carried out by authorised service technician.

1. Disconnect the mains supply.
2. Wait for 4 minutes to discharge the capacitors.
3. Remove the side panels on the power source.
4. Remove the top panel on the power source.
5. Remove the plastic cover between the heat sink and fan (b).
6. Clean the power source with dry compressed air (4 bar) as follows:
  - a) The upper rear part.
  - b) From the rear panel through the secondary heat sink.
  - c) The inductor, transformer and current sensor.
  - d) The power components side, from the rear side behind PCB 15AP1.
  - e) The PCBs at both sides.
7. Make sure that there is no dust left on any part.
8. Install the plastic cover between the heat sink and the fan (2) and make sure it is correctly fitted against the heat sink.
9. Do a test of the power source according to IEC 60974-4, follow the procedure in section "After repair, inspection and test" in the Service manual.
10. Install the top panel on the power source.
11. Install the side panels on the power source.
12. Connect the mains supply.

## 7 TROUBLESHOOTING

Try these recommended checks and inspections before sending for an authorized service technician.

Type of fault	Corrective action
No arc.	<ul style="list-style-type: none"> <li>• Check that the mains power supply switch is turned on.</li> <li>• Check that the mains, welding and return cables are correctly connected.</li> <li>• Check that the correct current value is set.</li> <li>• Check the mains power supply fuses.</li> </ul>
The welding current is interrupted during welding.	<ul style="list-style-type: none"> <li>• Check whether the overloading protection has deployed (indicated on the front).</li> <li>• Check the mains power supply fuses.</li> <li>• Check that the return cable is correctly fastened.</li> </ul>
The overheating protection trips frequently.	<ul style="list-style-type: none"> <li>• Make sure that you are not exceeding the rated data for the power source (i.e. that the unit is not being overloaded).</li> </ul>
Poor welding performance.	<ul style="list-style-type: none"> <li>• Check that the welding and return cables are correctly connected.</li> <li>• Check that the correct current value is set.</li> <li>• Check that the correct wire or electrode is used.</li> <li>• Check the mains power supply fuses.</li> <li>• Check the gas pressure in the equipment connected to the power source.</li> </ul>
"Err" on display in open circuit mode	<ul style="list-style-type: none"> <li>• Check the mains power supply fuses.</li> <li>• Check that the voltage on the voltage selection label on the rear of the power source is equal to the nominal mains voltage.</li> <li>• Restart the power source with the main switch.</li> </ul>
ECHO communication handshake between power source and feeder not detected (applicable for AVS ECHO).	<ul style="list-style-type: none"> <li>• Check that the welding method is set to AVS mode.</li> <li>• Check that the interconnection cables are connected properly.</li> </ul>

## 8 ORDERING SPARE PARTS

---



### CAUTION!

Repair and electrical work should be performed by an authorised ESAB service technician. Use only ESAB original spare and wear parts.

Warrior™ 500i ECHO CC/CV is designed and tested in accordance with the international and European standards **EN 60974-1** and **EN 60974-10 Class A**. On completion of service or repair work, it is the responsibility of the person(s) performing the work to ensure that the product still complies with the requirements of the above standards.

Spare parts and wear parts can be ordered through your nearest ESAB dealer, see [esab.com](https://www.esab.com). When ordering, please state product type, serial number, designation and spare part number in accordance with the spare parts list. This facilitates dispatch and ensures correct delivery.

# DIAGRAM

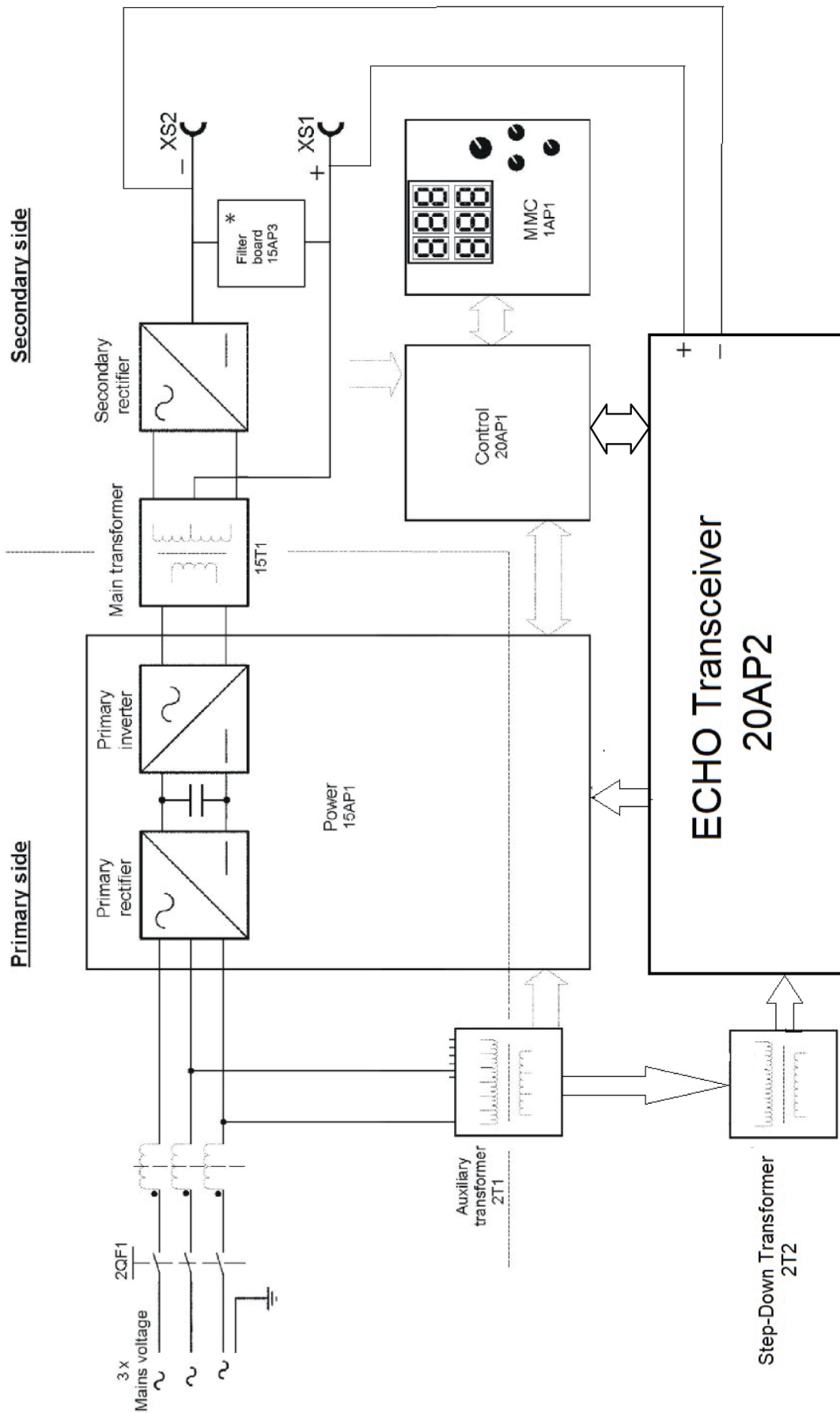

---

**ORDERING NUMBERS**

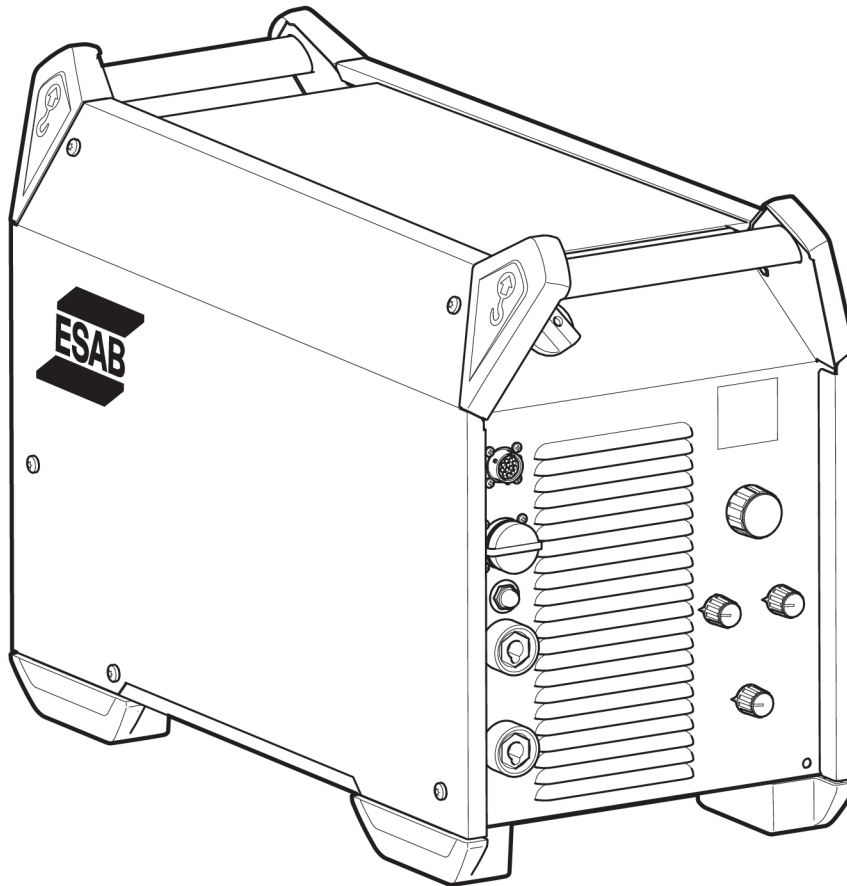

---





Ordering number	Denomination	Type	Notes
0448 550 880	Welding power source	Warrior™ 500i ECHO CC/CV	380-415 V CE
0464 254 001	Spare parts list		
0464 523 001	Service manual		

Technical documentation is available on the Internet at [www.esab.com](http://www.esab.com)

## ACCESSORIES

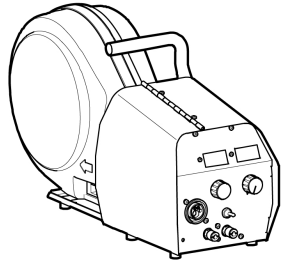
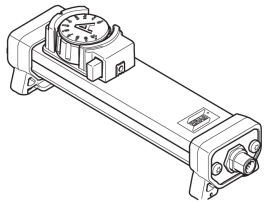

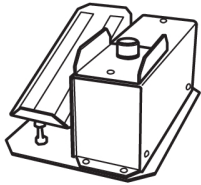
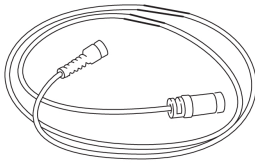
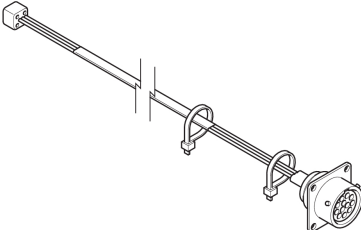
0445 800 880	<b>RobustFeed PRO</b> With EURO connector	
0445 800 881	<b>RobustFeed PRO, Water</b> With EURO connector and including torch cooling system	
0445 800 882	<b>RobustFeed PRO Offshore</b> With EURO connector, including gas flow meter and heater	
0445 800 883	<b>RobustFeed PRO Offshore, Water</b> With EURO connector and including torch cooling system, including gas flow meter and heater	
0445 800 884	<b>RobustFeed PRO, Tweco</b> With Tweco 4 connector	
0445 800 885	<b>RobustFeed PRO Offshore, Tweco</b> With Tweco 4 connector, including gas flow meter and heater	
0446 700 880	<b>RobustFeed AVS without Rotameter</b> with EURO connector	
0446 700 881	<b>RobustFeed AVS with Rotameter</b> with EURO connector	
0446 700 882	<b>RobustFeed AVS without Rotameter</b> with Tweco connector	
0446 700 883	<b>RobustFeed AVS with Rotameter</b> with Tweco connector	
0448 700 880	<b>RobustFeed AVS ECHO with Rotameter</b> with EURO connector	
0448 700 881	<b>RobustFeed AVS ECHO with Rotameter</b> with Tweco connector	

0465 250 881	<b>Warrior™ Feed 304w,</b> with water cooling	
0459 491 896	<b>Remote control unit AT1</b> MMA and TIG current	
0459 491 897	<b>Remote control unit AT1 CF</b> MMA and TIG: course and fine setting of current	
0349 090 886	<b>Foot control FS002</b> MMA and TIG: current	
<b>Remote control cable 12 pole - 8 pole</b>		
0459 552 880	5 m (16 ft.)	
0459 552 881	10 m (33 ft.)	
0459 552 882	15 m (49 ft.)	
0459 552 883	25 m (82 ft.)	
0465 424 880	<b>Remote outlet kit</b>	

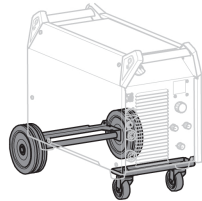
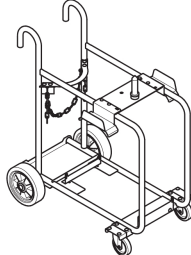
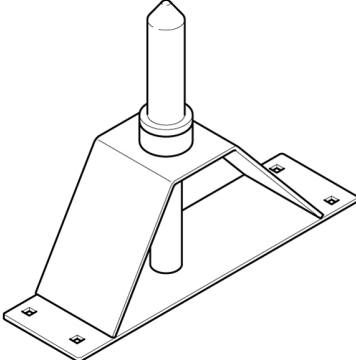
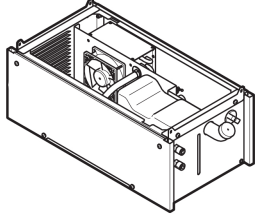
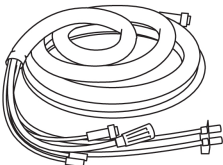
ACCESSORIES

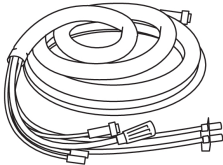
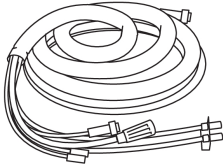
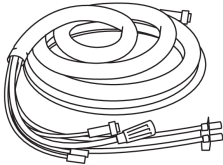
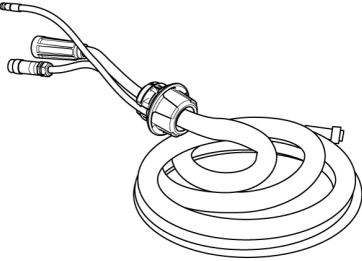
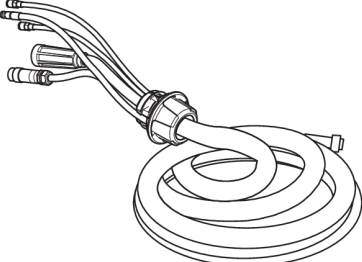
0465 416 880	<b>Wheel kit</b>	
0465 510 880	<b>Trolley</b>	
0465 508 880	<b>Guide pin extension kit</b> Used together with the trolley when the wire feed unit is equipped with wheel kit	
0465 427 880	<b>Cooling unit</b>	
<b>Interconnection cable without strain relief, Air cooled, 70 mm<sup>2</sup></b>		
0459 836 880	2 m (7 ft.)	
0459 836 881	5 m (16 ft.)	
0459 836 882	10 m (33 ft.)	
0459 836 883	15 m (49 ft.)	
0459 836 884	25 m (82 ft.)	
0459 836 885	35 m (115 ft.)	

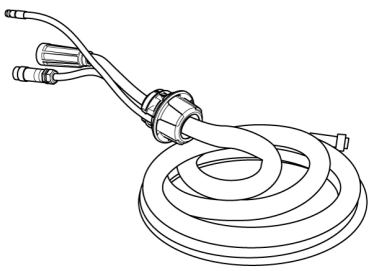
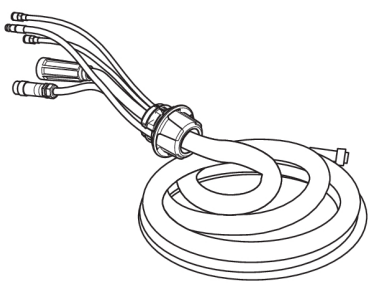
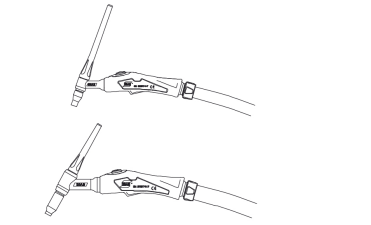
<b>Interconnection cable without strain relief, Liquid cooled, 70 mm<sup>2</sup></b>		
0459 836 890	2 m (7 ft.)	
0459 836 891	5 m (16 ft.)	
0459 836 892	10 m (33 ft.)	
0459 836 893	15 m (49 ft.)	
0459 836 894	25 m (82 ft.)	
0459 836 895	35 m (115 ft.)	
<b>Interconnection cable without strain relief, Air cooled, 95 mm<sup>2</sup></b>		
0459 836 980	2 m (7 ft.)	
0459 836 981	5 m (16 ft.)	
0459 836 982	10 m (33 ft.)	
0459 836 983	15 m (49 ft.)	
0459 836 984	25 m (82 ft.)	
0459 836 985	35 m (115 ft.)	
<b>Interconnection cable without strain relief, Liquid cooled, 95 mm<sup>2</sup></b>		
0459 836 990	2 m (7 ft.)	
0459 836 991	5 m (16 ft.)	
0459 836 992	10 m (33 ft.)	
0459 836 993	15 m (49 ft.)	
0459 836 994	25 m (82 ft.)	
0459 836 995	35 m (115 ft.)	
<b>Interconnection cable with pre-assembled strain relief, Air cooled, 70 mm<sup>2</sup></b>		
0446 160 880	2 m (7 ft.)	
0446 160 881	5 m (16 ft.)	
0446 160 882	10 m (33 ft.)	
0446 160 883	15 m (49 ft.)	
0446 160 884	25 m (82 ft.)	
0446 160 885	35 m (115 ft.)	
0446 160 887	20 m (66 ft.)	
<b>Interconnection cable with pre-assembled strain relief, Liquid cooled, 70 mm<sup>2</sup></b>		
0446 160 890	2 m (7 ft.)	
0446 160 891	5 m (16 ft.)	
0446 160 892	10 m (33 ft.)	
0446 160 893	15 m (49 ft.)	
0446 160 894	25 m (82 ft.)	
0446 160 895	35 m (115 ft.)	

<b>Interconnection cable with pre-assembled strain relief, Air cooled, 95 mm<sup>2</sup></b>		
0446 160 980	2 m (7 ft.)	
0446 160 981	5 m (16 ft.)	
0446 160 982	10 m (33 ft.)	
0446 160 983	15 m (49 ft.)	
0446 160 984	25 m (82 ft.)	
0446 160 985	35 m (115 ft.)	
<b>Interconnection cable with pre-assembled strain relief, Liquid cooled, 70 mm<sup>2</sup></b>		
0446 160 990	2 m (7 ft.)	
0446 160 991	5 m (16 ft.)	
0446 160 992	10 m (33 ft.)	
0446 160 993	15 m (49 ft.)	
0446 160 994	25 m (82 ft.)	
0446 160 995	35 m (115 ft.)	
<b>TIG torches</b>		
0700 300 539	TXH™ 151 V, OKC 50, 4 m	
0700 300 545	TXH™ 151 V, OKC 50, 8 m	
0700 300 553	TXH™ 201 V, OKC 50, 4 m	
0700 300 556	TXH™ 201 V, OKC 50, 8 m	
<b>Arc air torches</b>		
0468 253 880	Flair 600 incl monocable 2.5 m	
0468 253 016	Torch only	
0468 253 015	Monocable only	
0468 253 881	Flair 1600 incl monocable 2.5 m	
0468 253 036	Torch only	
0468 253 035	Monocable only	



# A WORLD OF PRODUCTS AND SOLUTIONS.



For contact information visit [esab.com](http://esab.com)

ESAB AB, Lindholmsallén 9, Box 8004, 402 77 Gothenburg, Sweden, Phone +46 (0) 31 50 90 00

[manuals.esab.com](http://manuals.esab.com)

